

Snap-Loc Systems

*Adjustable Length And
Interchangeable
Components*



WILTON
VERTICAL

Snap-Loc Systems

Adjustable Length And Interchangeable Components With Easy Hand Assembly

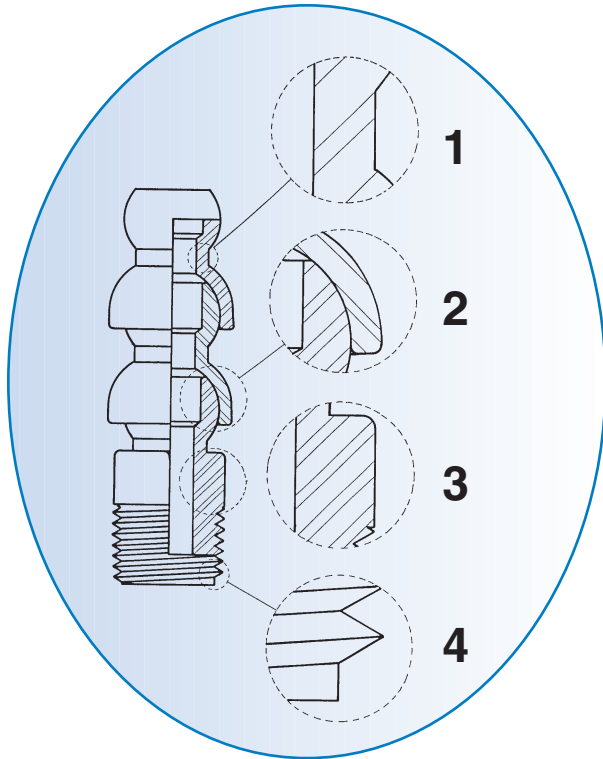

Fig. 1 Heavy-Duty Construction

Industrial grade wall thickness provides durable parts with long lasting performance.

Fig. 2 Bearing Surface & Snap Fit

Contribute to outstanding performance with respect to "jetting" and holding power. Snap-Loc Systems are designed for normal shop air and fluid pressures.

Fig. 3 Solid Hex Design

This solid hex design is superior to a ribbed design because it has less tendency to strip.

Fig. 4 Durable Thread Design

Cedarberg Snap-Loc Systems have milled, not turned, threads. This results in better starting threads, and less cross threading. Threads are easier to re-use.

FEATURES:

- Industrial Grade
- Adjustable Length
- Easy Hand Assembly
- Unrestricted Flow
- No Vibration Wandering
- Chemical Resistance
- Electrically Non-Conductive
- 3-Dimensional Adjustability

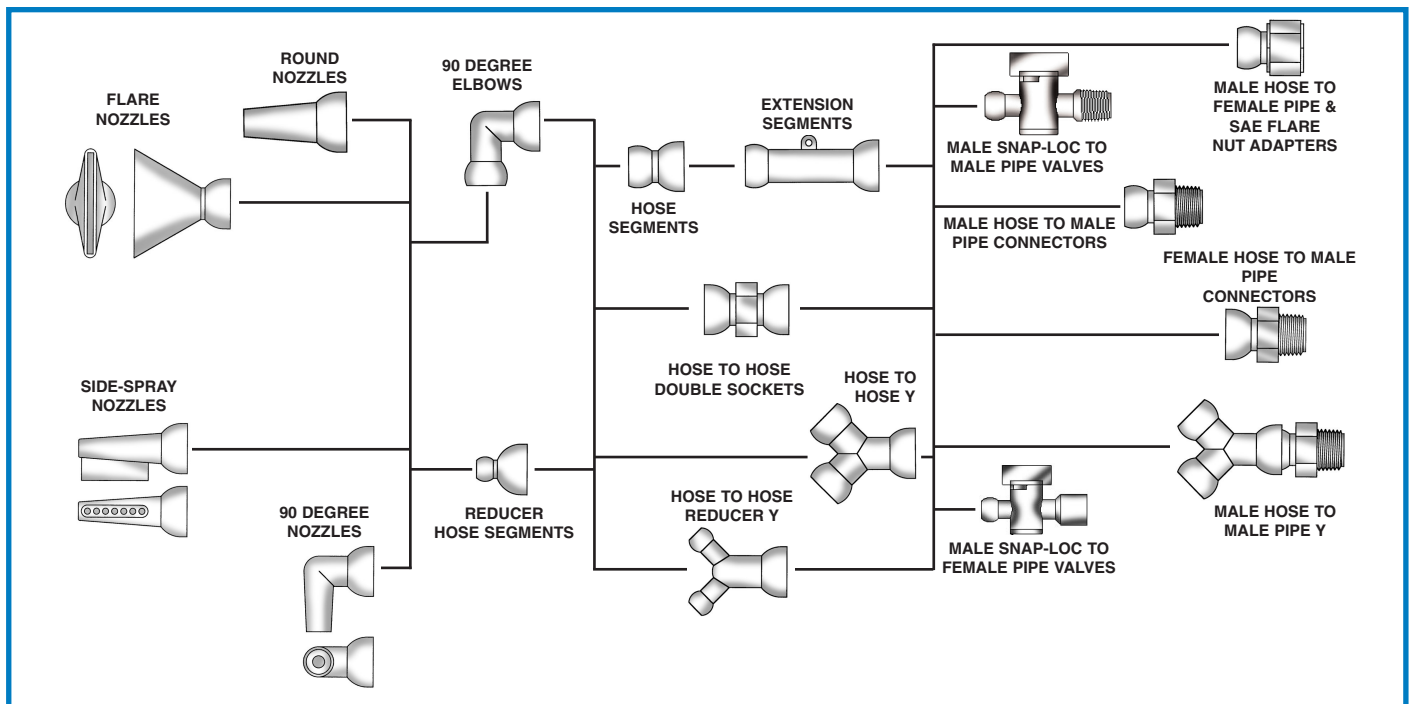

Snap-Loc Systems

*More Than
Just A
Coolant Hose...*

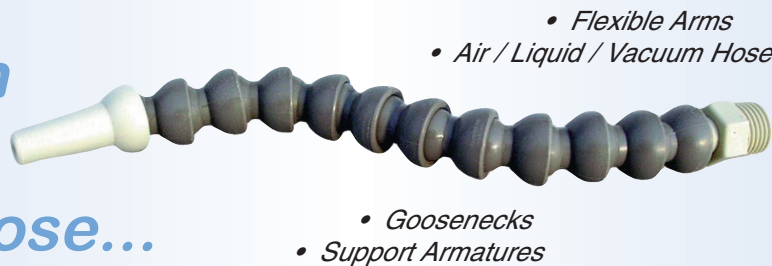

...An Element Of Ingenuity.

MORE THAN JUST A COOLANT HOSE...

- Since the beginning, Cedarberg Snap-Loc Systems have served metalworking industries world-wide. However, the 3-dimensional flexibility and holding power of our design serves well in a wide range of applications. We work with product designers in many fields because our Snap-Loc Systems are...
...An Element of Ingenuity.

INTERCHANGEABLE COMPONENTS:

- Snap-Loc components are interchangeable; Reducers are available for 3/4" to 1/2" hose, and for 1/2" to 1/4" hose, allowing for the use of all three hose sizes in a single installation.

EASY HAND ASSEMBLY:

- Snap-Loc assembly and disassembly is fast and easy. Assembly Pliers are available for the 1/4" and 1/2" Systems. The Universal Assembly Tool can be used for assembly of 1/4", 1/2" and 3/4" Systems. Separation Wedges for each of the three hose sizes simplify disassembly (Pg. 10).

HOSE BEND CAPABILITIES:

- Snap-Loc hose may be bent to form tight turns. Minimum center-line diameters are as follows:
 - 1/4" Hose; 2" center-line diameter
 - 1/2" Hose; 3-1/4" center-line diameter
 - 3/4" Hose; 5-1/4" center-line diameter

MATERIALS:

- Standard Snap-Loc Hose and Connector material is Delrin. Standard Nozzle material is polypropylene. Consult factory for alternate material availability.

CHEMICAL RESISTANCE:

- Delrin exhibits superior chemical resistance to alcohols, aldehydes, esters, ethers, hydrocarbons (gasolines, lubricants, hydraulic fluid), agricultural chemicals, many weak acids and bases.
- Polypropylene provides good chemical resistance to a wide variety of chemical products, including alkalies, solvents, as well as acids.

WORKING PRESSURES:

- Snap-Loc Systems components are designed for normal shop air and fluid pressures. They are not intended for high pressure applications. Maximum operating pressure is dependent upon many factors, including temperature of solution, hose and nozzle size, and whether pressure is induced slowly or instantaneously.

WORKING TEMPERATURES:

- Maximum recommended working Temperature for Snap-Loc Systems is approximately 200° F (93°C).

The Pac

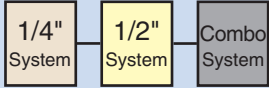

For Coolant Hose Set-Up And Quick Maintenance



CAT. NO.	QTY	DESCRIPTION	CODE
8525-282		Kit Includes:	AB
	4	1/4" x 12" Hose Assy	
	1	1/4" Extension Segment	
	2	1/16" Round Nozzle	
	2	1/8" Round Nozzle	
	2	1/4" Round Nozzle	
	2	1" Flare Nozzle	
	3	1/8" Connector	
	3	1/4" Connector	
	2	1/4" Y	
	1	1/4" Double Socket	
	1	1/4" Assembly Pliers	

CAT. NO.	QTY	DESCRIPTION	CODE
8550-321		Kit Includes:	AB
	4	1/2" x 12" Hose Assy	
	1	1/2" Extension Segment	
	2	1/4" Round Nozzle	
	2	3/8" Round Nozzle	
	2	1/2" Round Nozzle	
	2	2" Flare Nozzle	
	3	3/8" Connector	
	3	1/2" Connector	
	2	1/2" Y	
	1	1/2" Y X 1/4" Reducer Y	
	1	1/2" Double Socket	
	1	1/2" x 1/4" Adapter	
	1	1/2" Assembly Pliers	

CAT. NO.	QTY	DESCRIPTION	CODE
8550-322		Kit Includes:	AB
	3	1/4" x 12" Hose Assy	
	3	1/2" x 12" Hose Assy	
	1	1/4" Extension Segment	
	1	1/2" Extension Segment	
	2	1/4" x 1/16" Round Nozzle	
	2	1/4" x 1/8" Round Nozzle	
	2	1/4" x 1/4" Round Nozzle	
	2	1/2" x 1/4" Round Nozzle	
	2	1/2" x 3/8" Round Nozzle	
	2	1/2" x 1/2" Round Nozzle	
	2	1/4" x 1" Flare Nozzle	
	2	1/2" x 2" Flare Nozzle	
	3	1/4" x 1/8" Connector	
	3	1/4" x 1/4" Connector	
	3	1/2" x 3/8" Connector	
	3	1/2" x 1/2" Connector	
	1	1/4" Y	
	1	1/2" Y	
	1	1/2" x 1/4" Reducer Y	
	1	1/4" Double Socket	
	1	1/2" Double Socket	
	1	1/2" x 1/4" Adapter	
	1	1/4" Assembly Pliers	
	1	1/2" Assembly Pliers	

Connectors

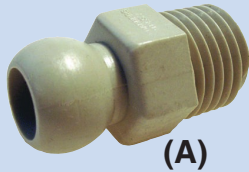
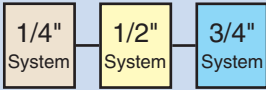

(A)

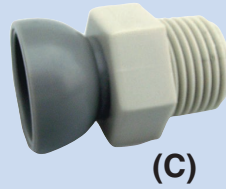

(C)

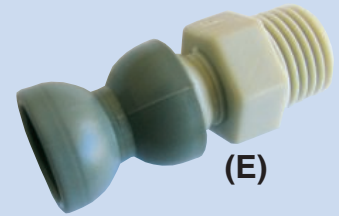

(E)



(B)

Connectors

CAT. NO.	DESCRIPTION	FIG. CODE
	Male Hose to Male Pipe Thread Connector (A)	
8425-17	1/8" NPT Pac of 4	A
8425-26	1/8" NPT Bag of 50	A
8425-18	1/4" NPT Pac of 4	A
8425-27	1/4" NPT Bag of 50	A
8525-177	1/8" BSPT Pac of 4	A
8525-178	1/8" BSPT Bag of 50	A
8525-179	1/4" BSPT Pac of 4	A
8525-180	1/4" BSPT Bag of 50	A

CAT. NO.	DESCRIPTION	FIG. CODE
	Male Hose to Female Pipe Thread Connector (B)	
8525-199	1/8" FPT Pac of 4	A
8525-200	1/8" FPT Bag of 50	A
8525-197	1/4" FPT Pac of 4	A
8525-198	1/4" FPT Bag of 50	A

CAT. NO.	DESCRIPTION	FIG. CODE
	Female Hose to Male Pipe Thread Connector (E)	
8525-103A	1/8" NPT Pac of 2	A
8525-130A	1/8" NPT Bag of 25	A
8525-104A	1/4" NPT Pac of 2	A
8525-131A	1/4" NPT Bag of 25	A
8525-167A	1/8" BSPT Pac of 2	A
8525-191A	1/8" BSPT Bag of 25	A
8525-170A	1/4" BSPT Pac of 2	A
8525-192A	1/4" BSPT Bag of 25	A

CAT. NO.	DESCRIPTION	FIG. CODE
	Male Hose to Male Pipe Thread Connector (A)	
8450-17	3/8" NPT Pac of 4	A
8450-26	3/8" NPT Bag of 50	A
8450-18	1/2" NPT Pac of 4	A
8450-27	1/2" NPT Bag of 50	A
8550-164	3/8" BSPT Pac of 4	A
8550-165	3/8" BSPT Bag of 50	A
8550-166	1/2" BSPT Pac of 4	A
8550-167	1/2" BSPT Bag of 50	A

CAT. NO.	DESCRIPTION	FIG. CODE
	Male Hose to Female Pipe Thread Connector (B)	
8550-188	1/2" FPT Pac of 4	A
8550-189	1/2" FPT Bag of 50	A

CAT. NO.	DESCRIPTION	FIG. CODE
	Female Hose to Male Pipe Thread Connector (C)	
8550-104	3/8" NPT Pac of 2	A
8550-135	3/8" NPT Bag of 25	A
8550-105	1/2" NPT Pac of 2	A
8550-136	1/2" NPT Bag of 25	A
8550-180	3/8" BSPT Pac of 2	A
8550-186	3/8" BSPT Bag of 25	A
8550-181	1/2" BSPT Pac of 2	A
8550-187	1/2" BSPT Bag of 25	A

CAT. NO.	DESCRIPTION	FIG. CODE
	Male Hose to Male Pipe Thread Connector (A)	
8475-18	3/4" NPT Pac of 4	A
8475-27	3/4" NPT Bag of 50	A
8475-18	3/4" BSPT Pac of 4	A
8475-27	3/4" BSPT Bag of 50	A

CAT. NO.	DESCRIPTION	FIG. CODE
	Female Hose to Male Pipe Thread Connector (C)	
8475-112	3/4" NPT Pac of 2	A
8475-113	3/4" NPT Bag of 25	A

Standard Material: Delrin 500
Polypropylene Available: Consult Factory
Standard Color: NPT Connectors Light Gray, BSPT Connectors Dark Gray, Hose Segments Dark Gray

Standard Material: Delrin 500
Polypropylene Available: Consult Factory
Standard Color: NPT Connectors Light Gray, BSPT Connectors Dark Gray, Hose Segments Dark Gray

Standard Material: Delrin 500
Polypropylene Available: Consult Factory
Standard Color: NPT Connectors Light Gray, BSPT Connectors Dark Gray, Hose Segments Dark Gray

Valves

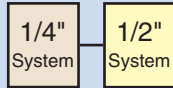

Plastic Snap-Loc Valves



CAT. NO.	DESCRIPTION	CODE	CAT. NO.	DESCRIPTION	CODE
8525-342	1/4" Male Snap-Loc x 1/4" Male NPT Black (1)	L	8525-344	1/4" Male Snap-Loc x 1/4" Female NPT Black (1)	L
8525-334	1/4" Male Snap-Loc x 1/4" Male NPT Black (2)	L	8525-340	1/4" Male Snap-Loc x 1/4" Female NPT Black (2)	L
8525-335	1/4" Male Snap-Loc x 1/4" Male NPT Black (10)	L	8525-341	1/4" Male Snap-Loc x 1/4" Female NPT Black (10)	L
8525-343	1/4" Male Snap-Loc x 1/4" Male BSPT Dk Gray (1)	L	8525-345	1/4" Male Snap-Loc x 1/4" Female BSPT Dk Gray (1)	L
8525-338	1/4" Male Snap-Loc x 1/4" Male BSPT Dk Gray (2)	L	8525-336	1/4" Male Snap-Loc x 1/4" Female BSPT Dk Gray (2)	L
8525-339	1/4" Male Snap-Loc x 1/4" Male BSPT Dk Gray (10)	L	8525-337	1/4" Male Snap-Loc x 1/4" Female BSPT Dk Gray (10)	L
8550-398	1/2" Male Snap-Loc x 1/2" Male NPT Black (1)	L	8550-400	1/2" Male Snap-Loc x 1/2" Female NPT Black (1)	L
8550-388	1/2" Male Snap-Loc x 1/2" Male NPT Black (2)	L	8550-394	1/2" Male Snap-Loc x 1/2" Female NPT Black (2)	L
8550-389	1/2" Male Snap-Loc x 1/2" Male NPT Black (10)	L	8550-395	1/2" Male Snap-Loc x 1/2" Female NPT Black (10)	L
8550-399	1/2" Male Snap-Loc x 1/2" Male BSPT Dk Gray (1)	L	8550-401	1/2" Male Snap-Loc x 1/2" Female BSPT Dk Gray (1)	L
8550-392	1/2" Male Snap-Loc x 1/2" Male BSPT Dk Gray (2)	L	8550-390	1/2" Male Snap-Loc x 1/2" Female BSPT Dk Gray (2)	L
8550-393	1/2" Male Snap-Loc x 1/2" Male BSPT Dk Gray (10)	L	8550-391	1/2" Male Snap-Loc x 1/2" Female BSPT Dk Gray (10)	L

Plastic Threaded Valves



CAT. NO.	DESCRIPTION	CODE	CAT. NO.	DESCRIPTION	CODE
8525-346	1/4" Male NPT x 1/4" Female NPT Black (1)	L	8525-352	1/4" Female NPT x 1/4" Female NPT Black (1)	L
8525-347	1/4" Male NPT x 1/4" Female NPT Black (2)	L	8525-353	1/4" Female NPT x 1/4" Female NPT Black (2)	L
8525-348	1/4" Male NPT x 1/4" Female NPT Black (10)	L	8525-354	1/4" Female NPT x 1/4" Female NPT Black (10)	L
8525-349	1/4" Male BSPT x 1/4" Female BSPT Dk Gray (1)	L	8525-355	1/4" Female BSPT x 1/4" Female BSPT Dk Gray (1)	L
8525-350	1/4" Male BSPT x 1/4" Female BSPT Dk Gray (2)	L	8525-356	1/4" Female BSPT x 1/4" Female BSPT Dk Gray (2)	L
8525-351	1/4" Male BSPT x 1/4" Female BSPT Dk Gray (10)	L	8525-357	1/4" Female BSPT x 1/4" Female BSPT Dk Gray (10)	L
8550-402	1/2" Male NPT x 1/2" Female NPT Black (1)	L	8550-408	1/2" Female NPT x 1/2" Female NPT Black (1)	L
8550-403	1/2" Male NPT x 1/2" Female NPT Black (2)	L	8550-409	1/2" Female NPT x 1/2" Female NPT Black (2)	L
8550-404	1/2" Male NPT x 1/2" Female NPT Black (10)	L	8550-410	1/2" Female NPT x 1/2" Female NPT Black (10)	L
8550-405	1/2" Male BSPT x 1/2" Female BSPT Dk Gray (1)	L	8550-411	1/2" Female BSPT x 1/2" Female BSPT Dk Gray (1)	L
8550-406	1/2" Male BSPT x 1/2" Female BSPT Dk Gray (2)	L	8550-412	1/2" Female BSPT x 1/2" Female BSPT Dk Gray (2)	L
8550-407	1/2" Male BSPT x 1/2" Female BSPT Dk Gray (10)	L	8550-413	1/2" Female BSPT x 1/2" Female BSPT Dk Gray (10)	L

Standard Material: Delrin 500.

Other Valves Available: Consult Factory.

Standard Colors: 1/4": NPT Black, BSPT Dk Gray
1/2": NPT Dk Gray, BSPT Dk Gray

Flood King/Manifold Kit/ Assembly & Separation Tools

Flood King



CAT. NO.	QTY	DESCRIPTION	CODE
8550-249		Flood King	C
		Kit Includes:	
	1	1/2" Ball Valve	
	4	1/2" x 12" Hose Assembly	
	4	Male Hose x 3/8" NPT Connectors	
	4	1/2" Nozzles	
	1	Manifold Block with Mounting Bracket	
	2	NPT Plugs	

FEATURES:

- Valve Control
- Up to four hose lines
- Interchangeable nozzles with different diameters
- Flexible Snap-Loc for direct flow into flood area
- Vibration wandering eliminated
- Stays in place
- High chemical resistance
- Any length or shape instantly available
- Multiple uses

Universal Manifold Kit

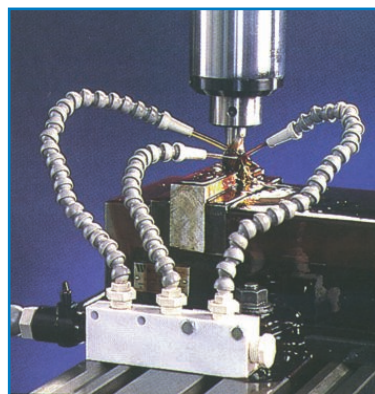

CAT. NO.	QTY	DESCRIPTION	CODE
8550-116		Universal Manifold Kit	C
		Kit Includes:	
	1	Manifold Block	
	1	Mounting Bracket	
	1	1/2" Female x 1/2" NPT Male Connector	
	1	1/2" NPT Ball Valve	
	2	1/2" NPT Close Nipple	
	3	3/8" NPT Close Nipple	
	6	3/8" NPT x 1/4" NPT Reducer Bushing	
	1	1/2" NPT Plug	
	1	3/8" NPT Plug	
	3	3/8" NPT Tee	
	2	1/4"-20 Hex Head Screw	
	2	1/4"-20 Hex Head Nut	

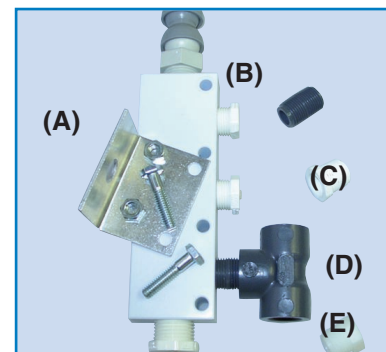

Manifold Kit Accessories

CAT. NO.	DESCRIPTION	Fig.	CODE
	Manifold Block & Mounting Bracket	(A)	
8550-121	Pac of 1 Set		C
8550-140	Bag of 6 Sets		O

Assembly & Separation Tools



Separation Wedges

CAT. NO.	DESCRIPTION	CODE
8701-030	1/4" Separation Wedge	O
8701-031	1/2" Separation Wedge	B
8701-032	3/4" Separation Wedge	O

BENEFITS:

- Simple tool slips easily over hose components for quick separation of parts
- Works well in awkward positions or on machines



Universal Assembly Tool

CAT. NO.	DESCRIPTION	CODE
8701-024	1/4" Universal Assembly Kit	B
8701-025	1/2" Universal Assembly Kit	B
8701-026	3/4" Universal Assembly Kit	B
8701-019	1/4" Line-Up Rod	B
8701-020	1/2" Line-Up Rod	B
8701-021	3/4" Line-Up Rod	B
8701-022	Push Bar	B
8701-023	Base	B

FEATURES:

- Simple to install and easy to use
- Assembles up to 12" hose lengths
- Purchase additional rods to assemble all sizes
- Assembles hose segments, as well as round nozzles and connectors of same size



Assembly Pliers

CAT. NO.	DESCRIPTION	CODE
8701-006	Assembly Pliers for 1/4" I. D. Systems	O
8701-007	Assembly Pliers for 1/2" I. D. Systems	O

BENEFITS:

- Get a tight grip on snap-fit
- Great for special assemblies
- Tool makes it easier to get leverage for assembly
- Eliminates frustration of assembly with oily hands or in awkward positions on machines
- Compatible with most "Brand X" hoses

Magna-Flow/E-Z Mist

Magna-Flow

Efficient Flow Control To Deliver Air / Liquid Coolant Where It Is Needed



FEATURES:

- Control valve allows convenient adjustment of air / coolant near work
- Barbed connection easily adapts to regulated shop air or machine coolant pump
- Magnetic Base (38 Lb. Pull) holds unit firmly in position
- Made of high quality non-corrosive materials
- Flexible hose can be easily directed and stays in position

BENEFITS:

- Extends tool life with precise coolant delivery
- Clears chips from work piece for easier visual inspection
- Great for EDM flushing
- Eliminates awkward support & adjustment
- Quickly transfers to other machines



Replacement Parts

CAT. NO.	DESCRIPTION	CODE
8525-262	Magna-Flow Single Pac Single 9" Length of 1/4" I.D. Hose 1/8" I.D. Nozzle	I
8525-263	Magna-Flow Dual Pac Two 9" Lengths of 1/4" I.D. Hose 1/8" I.D. Nozzle	I

APPLICATION NOTE:

- It is easy to adapt units for more nozzle outlets. Extra hose, Y-fittings, and nozzles may be purchased separately.

CAT. NO.	DESCRIPTION	CODE
8702-043	Mag Base Assembly	II
8525-342	1/4" SL x MPT Valve	L

E-Z Mist

Reliable Mist Flow With Precision Control



FEATURES:

- Get the right mist mixture with separate air and fluid controls
- Fully assembled, ready to use
- No special tank required
- Magnetic base can be easily repositioned
- Made of high quality non-corrosive materials

BENEFITS:

- Extend tool life with optimal heat dissipation
- Allows correct mist mixture for any job
- Chemical savings
- Flexible hose stays in position to direct mist flow with ease
- Maintenance minimized by in-line coolant filter

CAT. NO.	DESCRIPTION	CODE
8703-002	E-Z Mist Precision Control Kit Includes: 1/4" NPT Ball Valve 1/4" NPT Quick Disconnect 12" Hose Assembly with 1/8" Nozzle Pressure Gauge 1/4" Regulator Aspirator Foot Strainer 3/8" O.D. Tubing Magnetic Base	I

CAT. NO.	DESCRIPTION	CODE
6460-001	Aspirator Assembly With Strainer	II
8702-043	Mag Base Assembly	II
8525-346	1/4" MPT x FPT Valve	L
6420-001	Regulator	II
6480-001	1" Diameter Pressure Gauge	II
6530-001	Strainer Assembly	II
6501-002	3/8" O.D. Plastic Tubing (1 Ft)	II
8703-004	Precision Regulator Gauge Kit	II
8703-006	E-Z Mist 12" Hose Assembly with 1/8" Nozzle	II

APPLICATION NOTES:

- E-Z Mist Precision Control Kit utilizes a built in regulator so shop air can be directly applied. Maintain close pressure tolerances for maximum misting efficiency and maximum cost savings

Technical & Dimensional Data

1/4" Snap-Loc Dimensions (Inches)

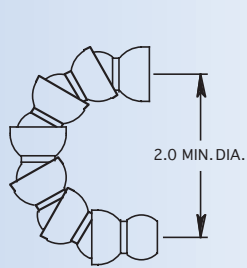

1/4" HOSE

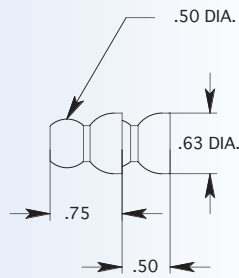

1/4" BODY SEGMENTS

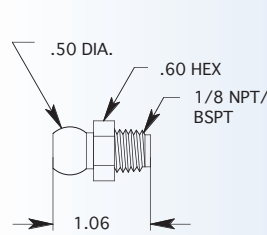

1/8" MALE CONNECTOR

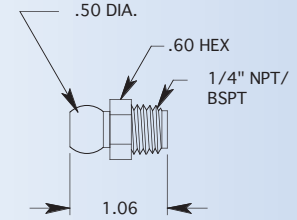

1/4" MALE CONNECTOR

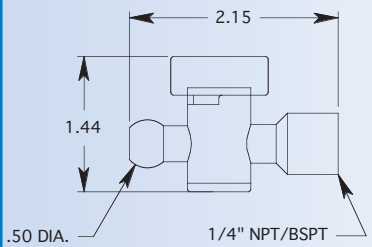

1/4" HOSE X 1/4" NPT/F BSPT VALVE

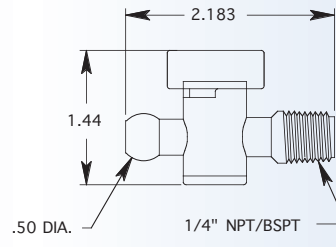

1/4" HOSE X 1/4" NPT/BSPT VALVE

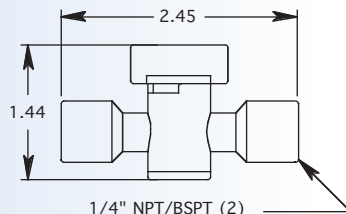

1/4" NPT/BSPT (2)
1/4" F NPT/BSPT X 1/4" F NPT/BSPT VALVE

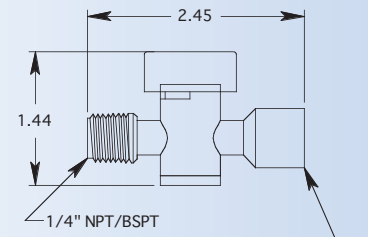

1/4" NPT/BSPT X 1/4" F NPT/F BSPT VALVE

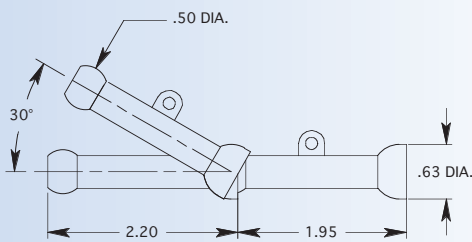

1/4" EXTENSION SEGMENTS

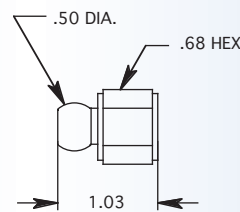

1/8" FPT FEMALE CONNECTOR
1/4" FPT FEMALE CONNECTOR

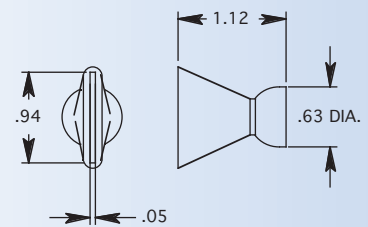

1" FLARE NOZZLE

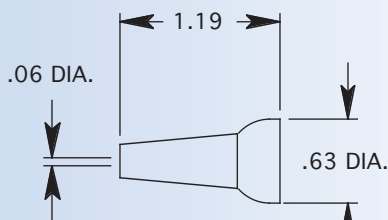

1/16" NOZZLE

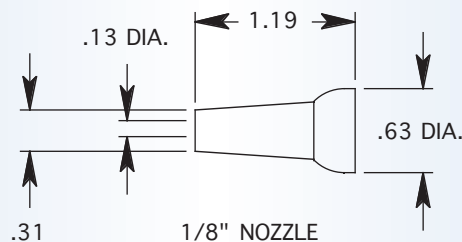

1/8" NOZZLE

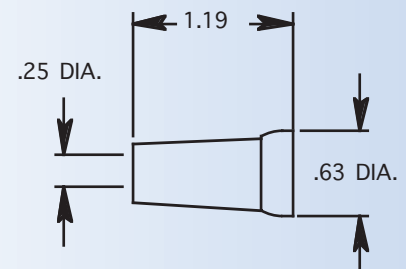

1/4" NOZZLE

Technical & Dimensional Data

1/4" Snap-Loc Dimensions (Inches)

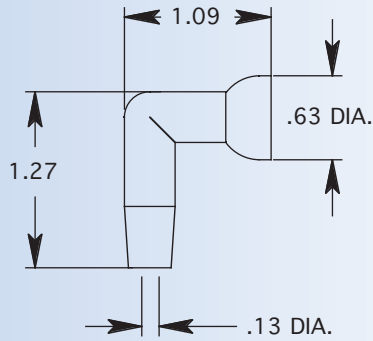

1/8" 90 DEGREE NOZZLE

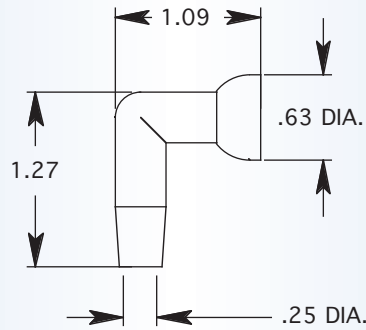

1/4" 90 DEGREE NOZZLE

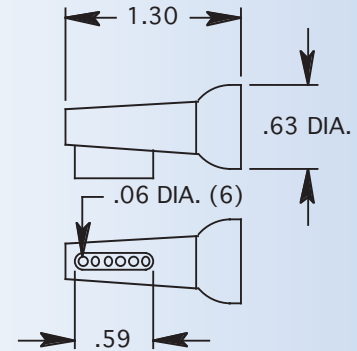

1/4" SIDE-SPRAY NOZZLE

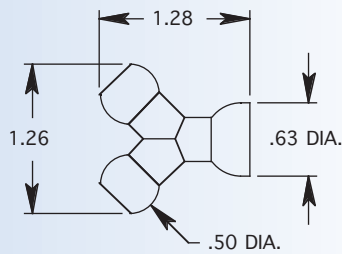

1/4" Y

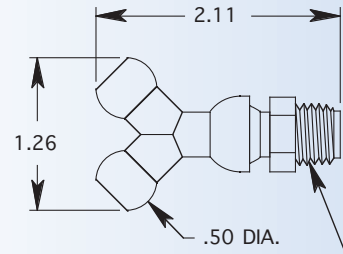

1/4" Y X 1/8" & 1/4" CONNECTOR MOLDED

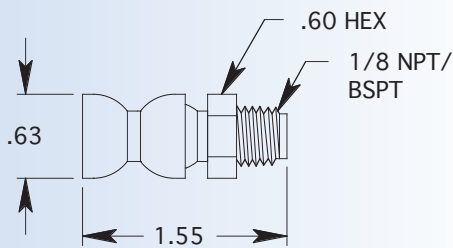

1/4" F HOSE X 1/8" CONNECTOR

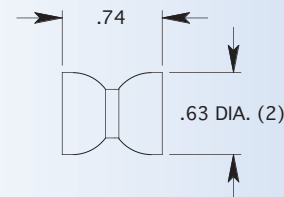

1/4" DOUBLE SOCKET ADAPTER

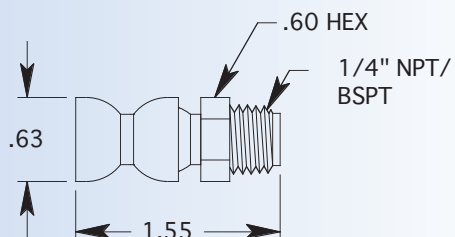

1/4" F HOSE X 1/4" CONNECTOR

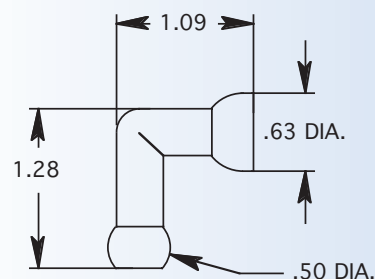

1/4" 90 DEGREE ELBOW

Technical & Dimensional Data

1/2" Snap-Loc Dimensions (Inches)

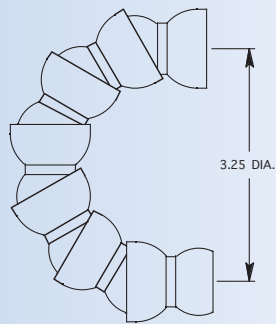

1/2" HOSE

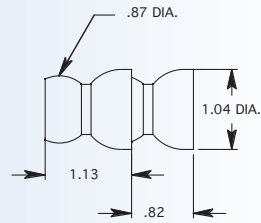

1/2" BODY SEGMENTS

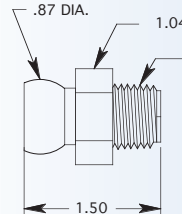

3/8" MALE CONNECTOR

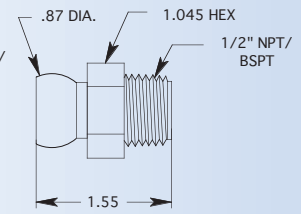

1/2" MALE CONNECTOR

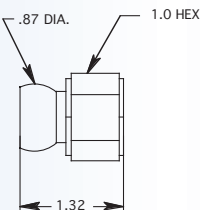

3/8" FPT FEMALE CONNECTOR
1/2" FPT FEMALE CONNECTOR

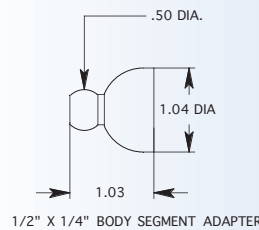

1/2" X 1/4" BODY SEGMENT ADAPTER

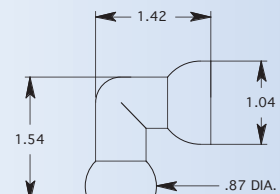

1/2" 90 DEGREE ELBOW

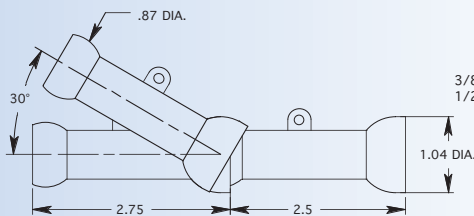

1/2" EXTENSION SEGMENTS

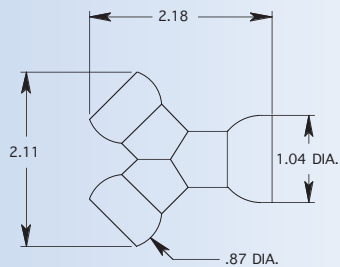

1/2" Y MOLDED

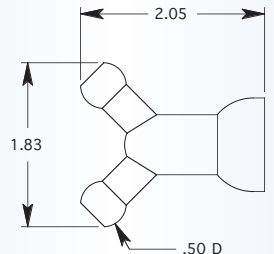

1/2" X 1/4" REDUCER Y - MOLDED STYLE

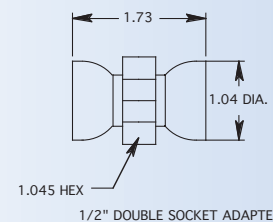

1/2" DOUBLE SOCKET ADAPTER

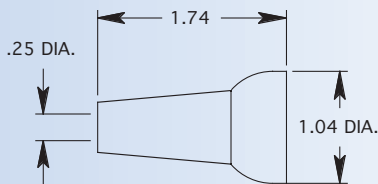

1/4" NOZZLE
1/4" NOZZLE

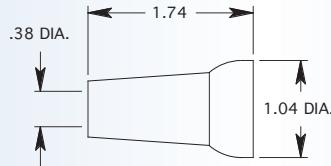

3/8" NOZZLE

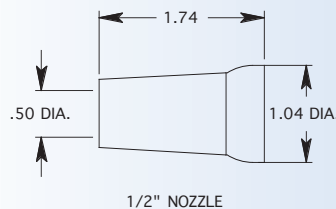

1/2" NOZZLE

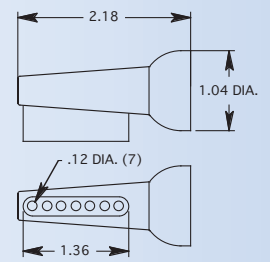

1/2" SIDE-SPRAY NOZZLE

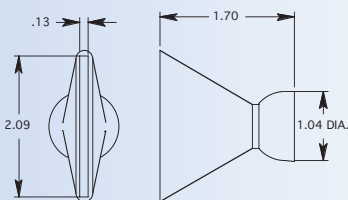

2" FLARE NOZZLE

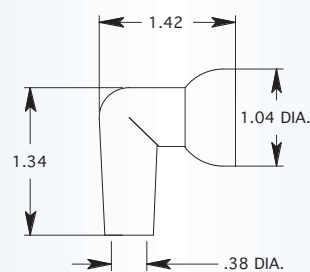

3/8" 90 DEGREE NOZZLE

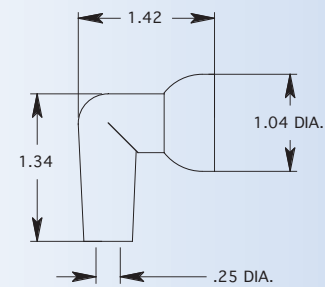

1/4" 90 DEGREE NOZZLE

Technical & Dimensional Data

1/2" Snap-Loc Dimensions (Inches)

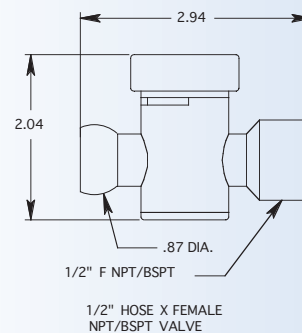
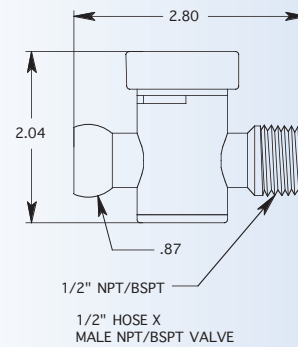
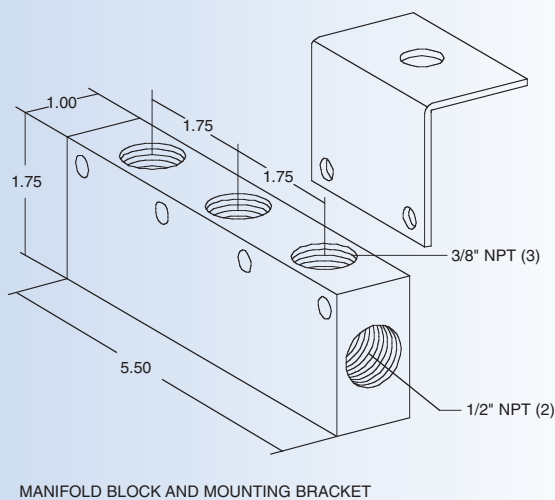
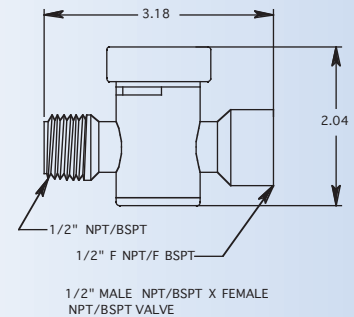
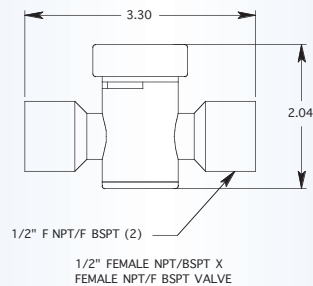
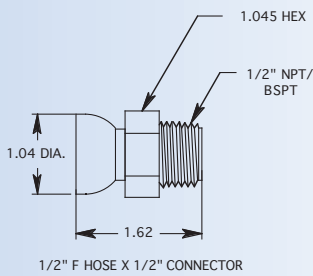
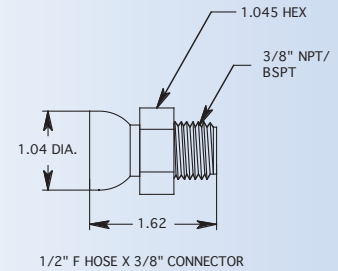
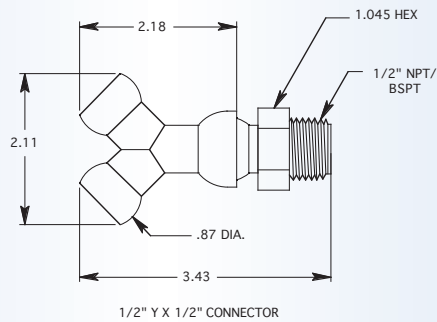
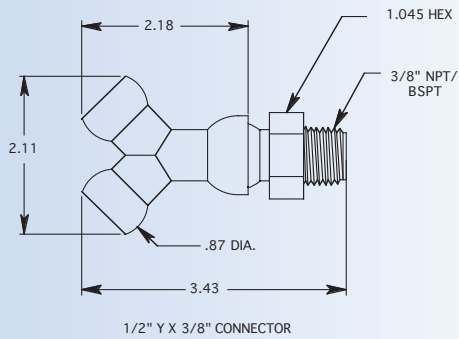

Technical & Dimensional Data

3/4" Snap-Loc Dimensions (Inches)

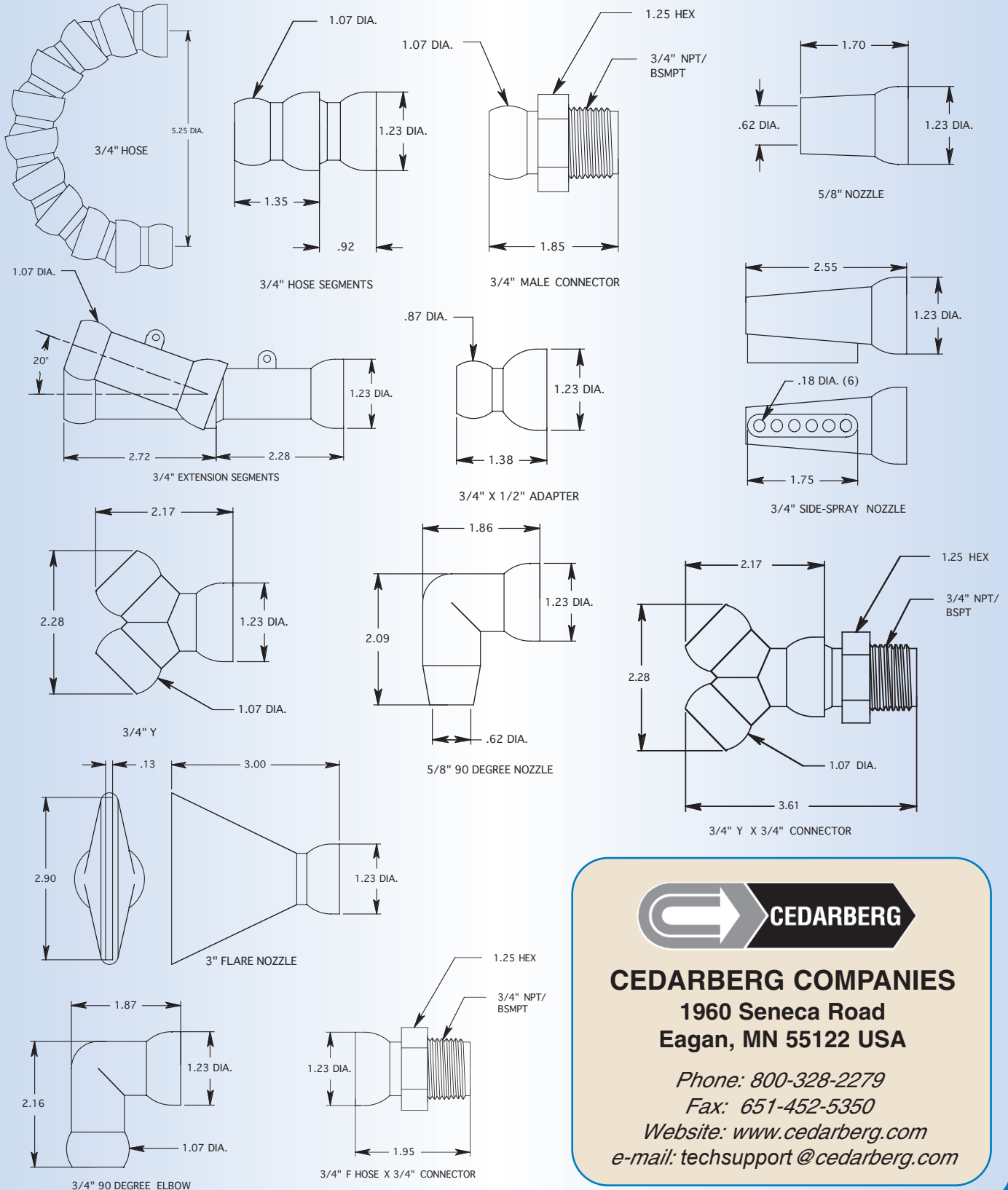

CEDARBERG COMPANIES

**1960 Seneca Road
Eagan, MN 55122 USA**

Phone: 800-328-2279

Fax: 651-452-5350

Website: www.cedarberg.com

e-mail: techsupport@cedarberg.com